



BD Rowa™ Vmotion

Technical Data

Monitor Overview:





Digital visual and free selection

Technical Data							
Type	Touch					Non-Touch	
Size	22"	32"	49"	55" (black)	55" (white)	55"	55" Panorama
Brightness (nit)	350	500	420	400	400	500	500
Power consumption in On mode (watts)*	18	60	135	180	180	89	138
Power consumption in Standby mode (watts)*	1,5	1,5	1,5	96	96	0,5	< 0,5
Operating Hours	Not 24/7	24/7	24/7	24/7	24/7	24/7	24/7
Server (1–2 monitors per Server)	NUC	NUC	NUC	SoC**	SoC**	NUC	NUC
Web Application	Vmotion Cloud	Vmotion Cloud	Vmotion Cloud	Vmotion Cloud	Vmotion Cloud	Vmotion Cloud	Vmotion Cloud
External dimensions (H x W x D)	517.5 x	738.7 x	1,130 x	1,295 x	1,295 x	1,239.7 x	1,213.4 x
	313.5 x	439.9 x	660.5 x	765 x	765 x	712.5 x	684.2 x
	46 mm	67 mm	72.5 mm	76 mm	76 mm	38.6 mm	114.39 mm

* For the two 55" touch monitors, the energy consumption specification applies including the integrated computer. For the other monitors, the consumption of the external NUC is not included (120W).

** SoC = System on Chip – Mediaplayer integrated in monitor

Mounting Options

Type	-	Touch					Non-Touch	
Size	-	22"	32"	49"	55" (black)	55" (white)	55"	55" Panorama
Table Installation		✓	✗	✗	✗	✗	✗	✗
Table Pole Installation		✓	✓	✗	✗	✗	✗	✗
Wall Mounting		✗	✗	✓	✓	✓	✓	✓
Stand		✗	✗	✗	✗	✗	✗	✓
Stand mobile		✗	✗	✗	✗	✗	✗	✓

Other

Specification NUC:	BD Rowa™ Vmotion Intel NUCi3 250 GB SSD, 115 × 111 × 36 mm (W × H × D) Internal Mediaplayer
--------------------	---

The permissible ambient conditions of the monitors with respect to temperature and humidity must be observed.









Direct sunlight damages the monitors. If the installation location is in direct sunlight, apply a UV filter film to the outer window in front of the monitors.

Monitor Overview:

Digital showcase

Technical Data		
Type	Non-Touch Semi Outdoor Rowa	
Size	55"	75"
Brightness (nit)	2,500	3,000
Power consumption in on state (Watts)*	295	400
Power consumption in standby operation (Watts)*	< 0,5	< 0,5
Operating Hours	24/7	24/7
Server (1–2 monitors per Server)	NUC	NUC
Web Application	Vmotion Cloud	Vmotion Cloud
External dimensions (H x W x D)	1,233.2 x 714 x 137.7 mm	1,681.2 x 955.6 x 142.4 mm

* In the case of the energy consumption specifications, the consumption of the external NCU is not included (120W).

Mounting Options			
Wall Mounting			
Stand			
Mobile stand			

Other	
Specification NUC:	BD Rowa™ Vmotion Intel NUCi3 Windows 10, 250 GB SSD, 115 x 111 x 36 mm (W x H x D) Internal Mediaplayer

The permissible ambient conditions of the monitors with respect to temperature and humidity must be observed.

Direct sunlight damages the monitors. If the installation location is in direct sunlight, apply a UV filter film to the outer window in front of the monitors.

Mounting Options:

Stand

Stand dimensions

Size	Stand XL	Stand XXL	Round*
Baseplate (W x D x H)	880 x 600 x 8 mm	980 x 700 x 8 mm	Ø180 x 8 mm
Monitor Size	55"	75"	Single tube: 55" Double tube: 75"

*Ground anchoring needed

Freestanding stand

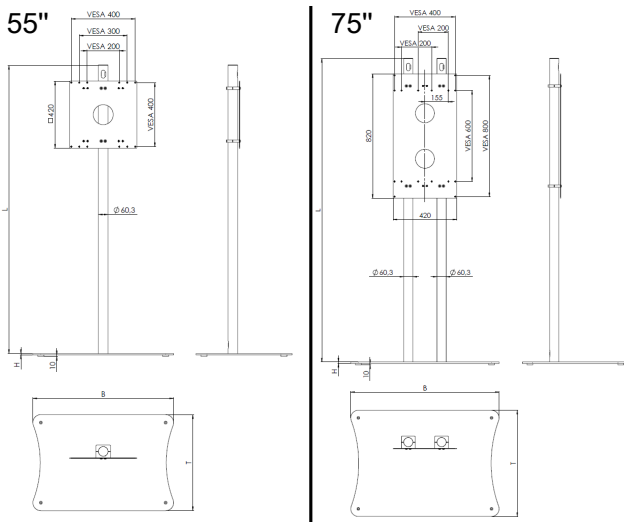

Each stand comes with a mounting tube in the following length (L):

Monitor size 55": 1,200 mm / 1,500 mm / 1,800 mm (depending on the variant selected)

Monitor size 75":
2,000 mm

When ordering an article with the addition of a "single tube", one base stand and one mounting tube are supplied.

When ordering an article with the addition of a "double tube", two base stands and two mounting tubes are supplied.

Mobile stand

55" / 75"

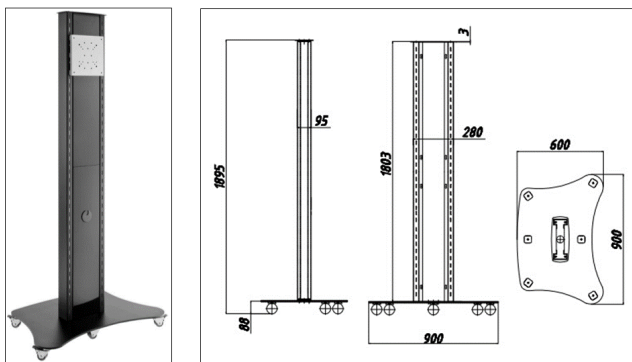

Small stand*

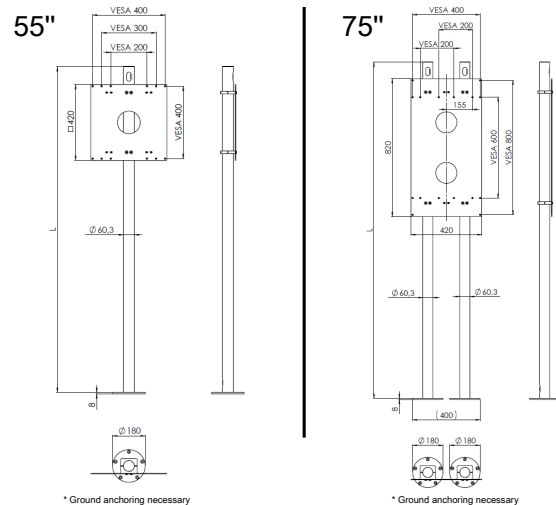

* Ground anchoring necessary

* Ground anchoring necessary

Installation Recommendations:

Digital visual selection

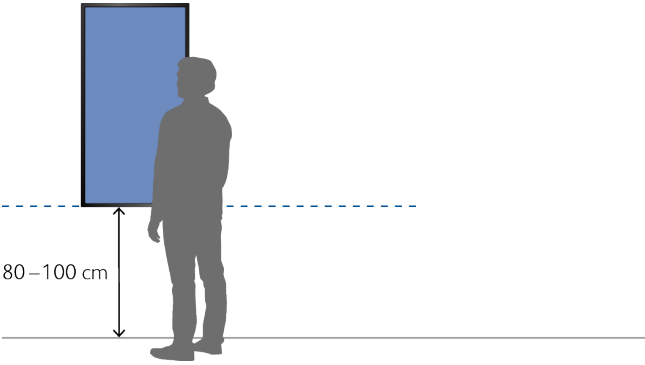
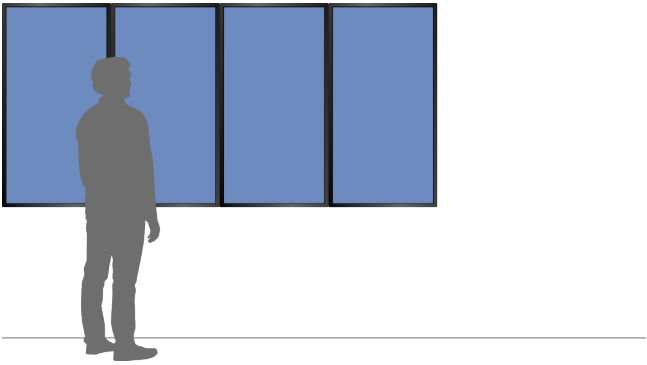
Distance to the Floor	Panorama Installation
 <p>80-100 cm</p>	
<p>For ideal presentation of the monitor content, a (<i>floor to monitor</i>) distance of 80 – 100 cm is recommended.</p>	<p>To realize an attractive panorama installation, monitors with the narrowest possible frame – e.g. 55" Panorama – should be used.</p>

Positioning of the monitors at the height adjustment

When positioning the monitors, ensure that they are not completely hidden by the counter and that the output slot is ergonomically positioned.

Fully Digital	Wall Mounting, Behind the height adjustment table
	

Table Installation

With both the table pole and table installation, make sure that there is a distance of at least 5 cm from the edge of the table. Furthermore, for the table installation, the monitor must be sunk 5 cm into the table.

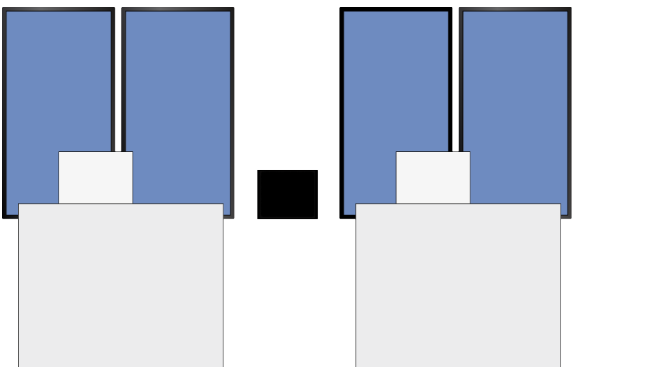
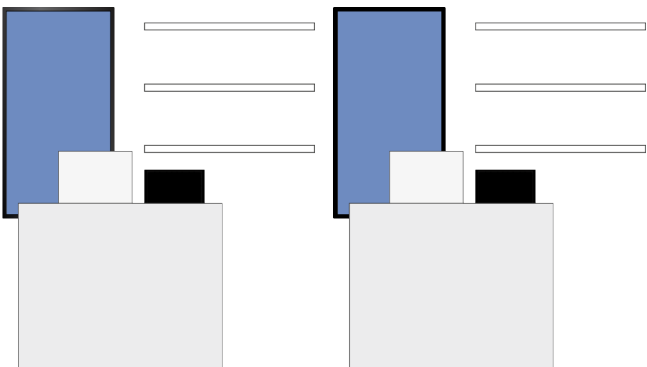
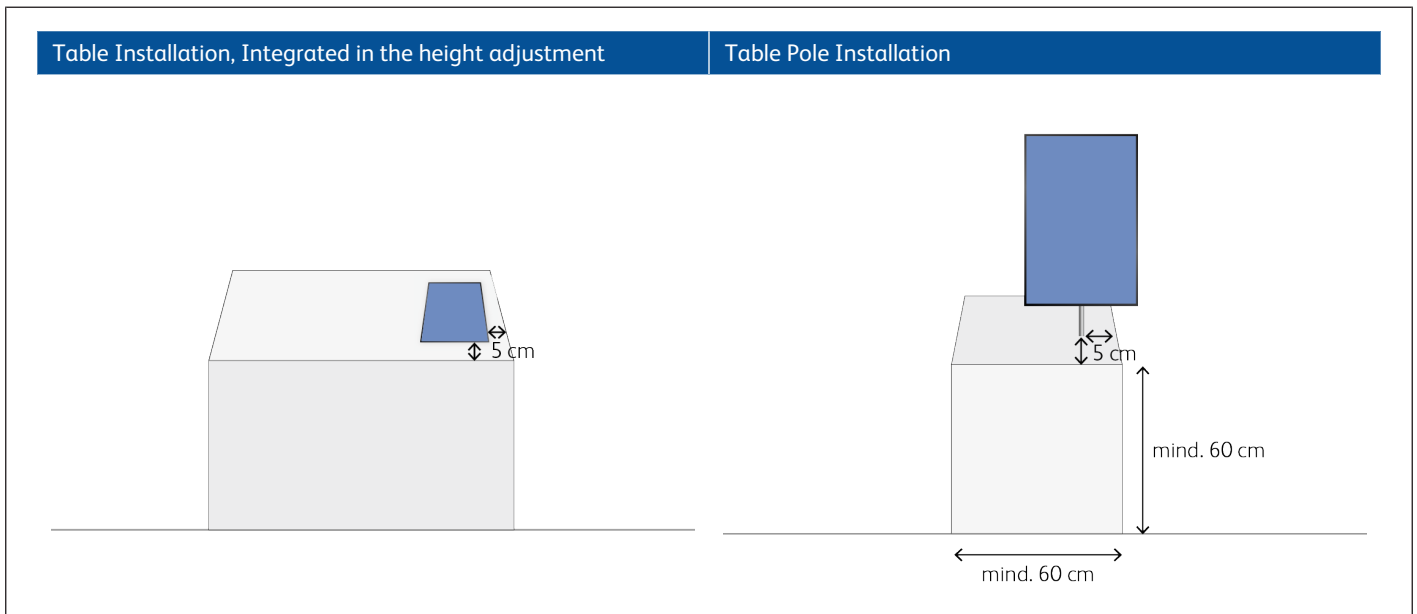

Installation Recommendations:

Digital Free Choice

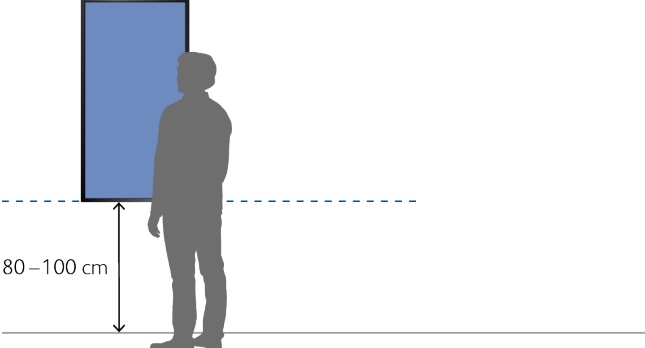
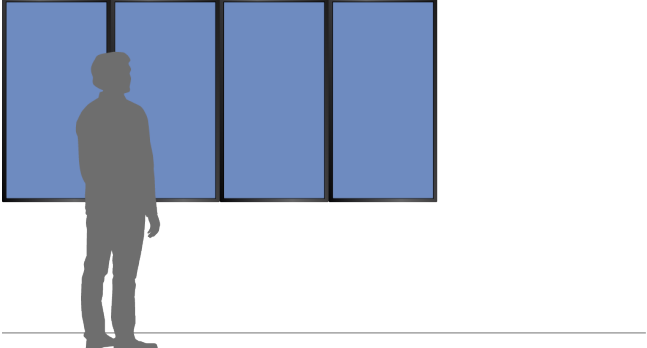
Distance to the Floor	Panorama Installation
	
<p>For ideal presentation of the monitor content, a (<i>floor to monitor</i>) distance of 80 – 100 cm is recommended.</p>	<p>To realize an attractive panorama installation, monitors with the narrowest possible frame – e.g. 55" Panorama – should be used.</p>

Positioning of monitors in the office

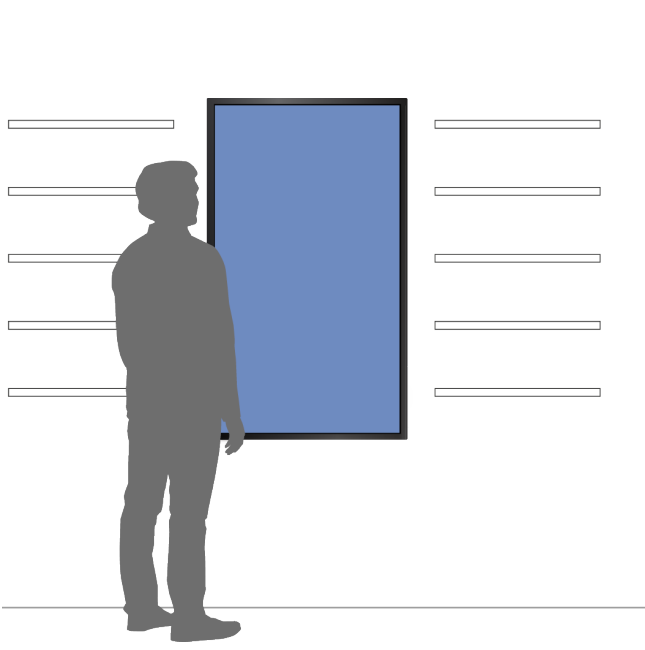
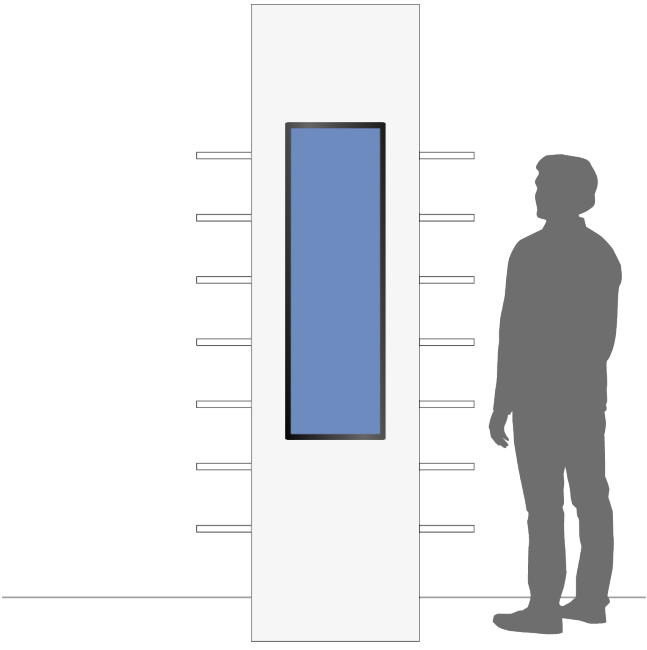
Integration in Shelving	Integration in Column
	

Installation Recommendations:

Digital Shopping Window—Choosing the Right Monitor Size in Just Three Steps

1. Center of Image

To ensure optimal appreciation of the monitor content, we recommend positioning the center of the monitor at a height of approximately 160 cm (+/- 5 cm) – measured from the sidewalk.

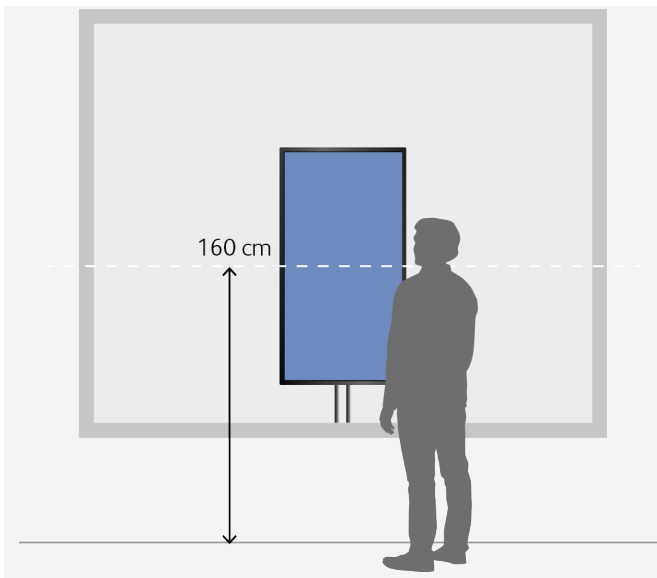

2. Distance from Window Frame

Ensure a distance of at least 15 cm between the edge of the monitor and the window frame to allow the contents to be displayed to their best advantage.

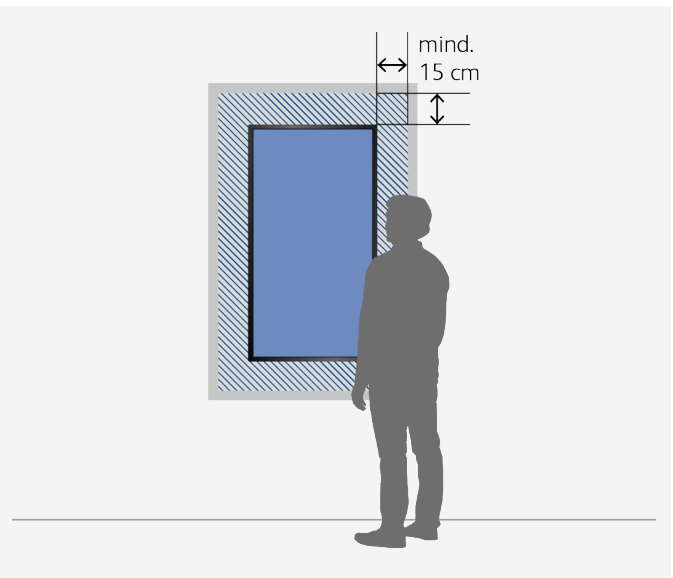

3. Support surface and Height in the Shop Window

① Distance monitor to window

Ideal:	10 cm
Minimum:	5 cm
Maximum:	40 cm

② Support surface of the stand

Stand XL (55"):	880 mm x 600 mm (W x D)
XXL stand (75"):	980 mm x 700 mm (W x D)
Round	Ø180 mm

③ Height of the stand rod

The stand rod should extend 30 cm beyond the brackets in the center of the monitor.

Available Sizes: 1,200 mm, 1,500 mm, 1,800 mm, (Standard), 2,000 mm (only for stand XXL)

